

2A 1.5MHz Synchronous Step-Down DC/DC Converter

GENERAL DESCRIPTION

The XM5203 synchronous buck converter is a high frequency step-down voltage regulator with current control mode. It can output 2A with excellent line and load regulation. The current is only 130uA at operating and less than 1uA at shutdown. This device is the ideally solution for small space and battery powered consume application, such as cellular phone and Hand-held device.

The XM5203 integrates PWM controller, power switch and compensation network, required only five components to implement a 2A output switching power supply. It has internal fixed 1.5MHz frequency and makes application circuit smaller.

The XM5203 is available in an adjustable output voltage version. The adjustable version has wide output range from 0.6V to VIN. The XM5203 series products are available in a DFN3X3-10L package.

FEATURES

- 2.5V to 5.5V Input Range
- 2A Output Capability
- High Efficiency up to 95%
- Low Quiescent Current 130uA
- Adjustable Output Voltage from 0.6V to VIN
- 1.5MHz Constant Frequency Operation
- Low Dropout Operation: 100% Duty Cycle
- Under Voltage Lockout, Over Current, Short Current, and Thermal Protection
- Operating Temperature: -40°C to +85°C
- Available in very tiny DFN3X3-10L Package
- RoHS Compliant and 100% Lead(Pb)-Free

Applications

- Handheld Instruments
- MP3/4 Player
- DSP Core Supplies
- Board Mounted Power Supplies

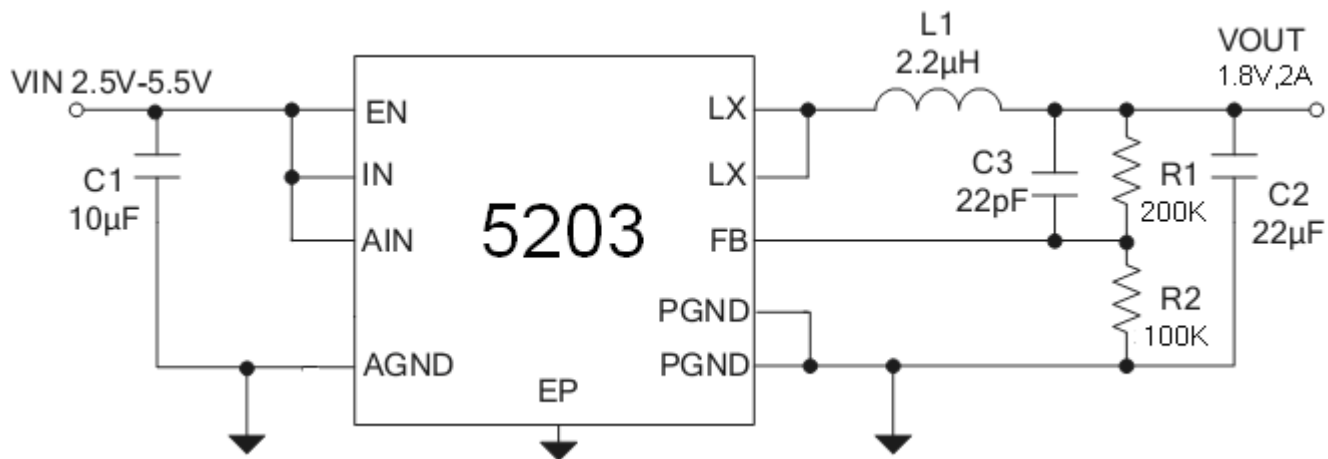

Figure 1. Typical Application Circuit

ORDERING INFORMATION

PART NUMBER	TEMP RANGE	SWICHING FREQUENCY	OUTPUT VOLTAGE (V)	OUTPUT CURRENT (A)	PACKAGE	PINS
XM5203	-40°C to 85°C	1.5MHz	Adjustable	2	DFN3X3	10

PIN CONFIGURATION

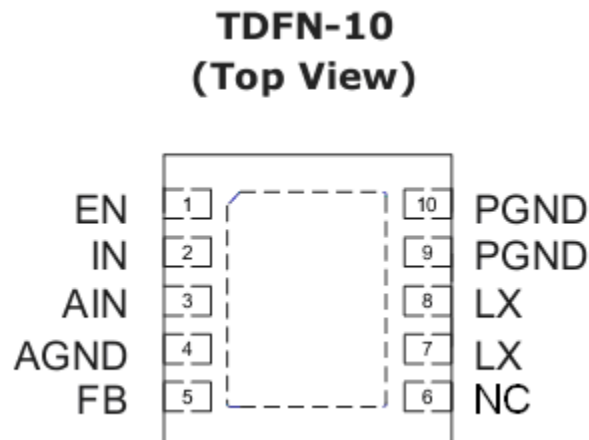

Figure 2. PIN Configuration

PIN DESCRIPTION

PIN #	NAME	FUNCTION
1	EN	Enable Input. EN is a digital input that turns the regulator on or off. Drive EN high to turn on the regulator, driver it low to turn it off.
2	VIN	Power Input. VIN supplies the power to the IC, as well as the step-down converter switches. Driver VIN with a 2.5 to 5.5V power source. Bypass VIN to GND with a suitably large capacitor to eliminate noise on the input to the IC.
3	AVIN	Anolog supply input pin
4	AGND	Anolog gound pin
5	FB	Feedback Input. FB senses the output voltage to regulator that voltage. Drive FB with a resistive voltage divider from the output voltage. The feedback threshold is 0.6V
6	NC	No connect
7,8	LX	Power Switching Output. SW is the switching node that supplies power to the output. Connect the output LC filter from SW to the output load.
9,10	PGND	Power ground pin
	EP	Power ground exposed pad

ABSOLUTE MAXIMUM RATINGS

(Note: Do not exceed these limits to prevent damage to the device. Exposure to absolute maximum rating conditions for long periods may affect device reliability.)

PARAMETER	VALUE	UNIT
Supply Voltage V_{IN}	-0.3V to +6V	V
FB, EN Voltage	-0.3V to $V_{IN}+0.3V$	V
SW Voltage	-0.3V to $V_{IN}+0.3V$	V
Operating Ambient Temperature	-40 to 85	°C
Maximum Junction Temperature	125	°C
Storage Temperature	-55 to 150	°C
Lead Temperature (Soldering, 10 sec)	300	°C

ELECTRICAL CHARACTERISTICS

($V_{IN} = 3.6V$, $T_A = 25^\circ C$ unless otherwise specified)

PARAMETER	SYMBOL	TEST CONDITIONS	MIN	TYP	MAX	UNIT
Input Voltage Range	V_{IN}		2.5		5.5	V
UVLO Threshold	V_{UVLO}	$V_{HYSTERESIS} = 100mV$	2.35	2.45	2.5	V
Operating Supply Current	I_{SUPPLY}	$V_{FB} = 0.5V$ or $V_{OUT} = 90%$, $I_{Load} = 0$		130	170	μA
Shutdown Supply Current		$V_{EN} = 0V$, $V_{IN} = 4.2V$		0.1	1	
Regulated Feedback Voltage	V_{FB}	$T_a = 25^\circ C$	0.588	0.6	0.612	V
		$0 < T_a < 85^\circ C$	0.5865	0.6	0.6135	
		$-40^\circ C < T_a < 85^\circ C$	0.585	0.6	0.615	
Reference Voltage Line Regulation		$V_{IN} = 2.7V$ to $5.5V$		0.04	0.4	%
Regulated Output Voltage	V_{OUT}	$V_{OUT} = 1.8V$; $I_{OUT} = 100mA$	1.746	1.8	1.854	V
Output Voltage Load Regulation				0.5		%
Peak Inductor Current	I_{PEAK}	$V_{IN} = 3V$, $V_{FB} = 0.5V$ or $V_{OUT} = 90%$, Duty Cycle $< 35%$		3.2		A
Oscillator Frequency	F_{OSC}	$V_{FB} = 0.6V$ or $V_{OUT} = 100%$	1.2	1.5	1.8	MHz
		$V_{FB} = 0$ or $V_{OUT} = 0$		220		KHz
Rds(ON) of P-channel FET		$I_{SW} = 100mA$		0.15	0.3	Ohm
Rds(ON) of N-channel FET		$I_{SW} = 100mA$		0.11	0.2	Ohm

Enable Threshold	$V_{IN} = 2.5V \text{ to } 5.5V$	0.3	1	1.5	V
Enable Leakage Current		-0.1		0.1	μA
SW Leakage Current	$V_{EN} = 0V, V_{SW} = 0V \text{ or } 5V, V_{IN} = 5V$	-1		1	μA

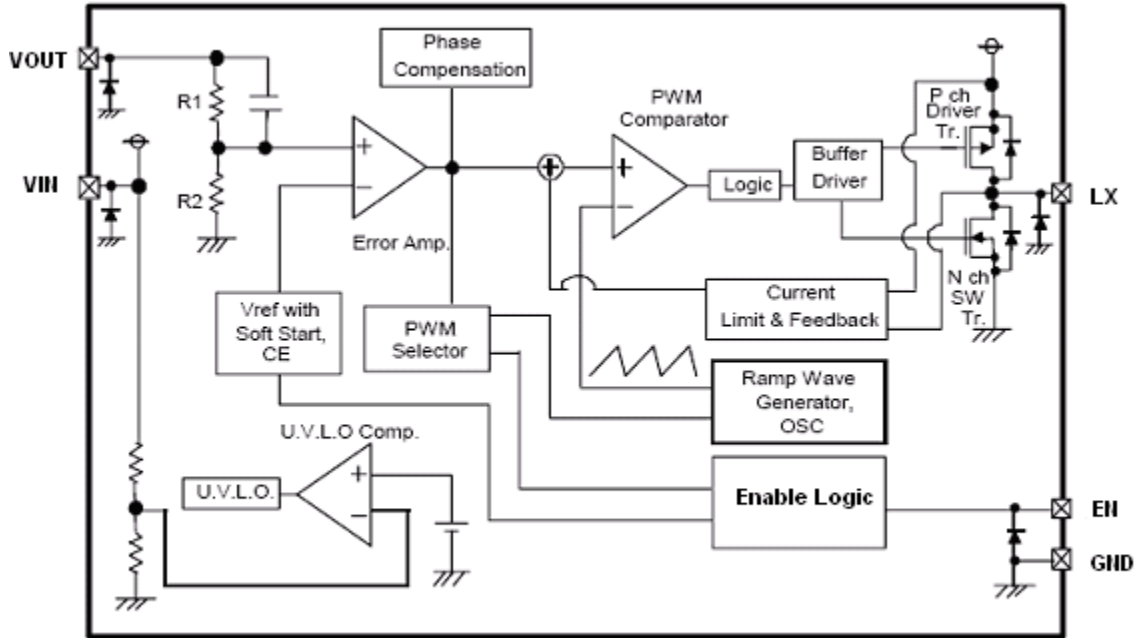

Figure 3. Functional Block Diagram

FUNCTIONAL DESCRIPTION

NORMAL OPERATION

In normal operation the high-side MOSFET turns on each cycle and remains on until the current comparator turns it off. At this point the low-side MOSFET turns on and remains on until either the end of the switching cycle or until the inductor current approaches zero. The error amplifier adjusts the current comparator's threshold as necessary in order to ensure that the output remains in regulation.

OVER CURRENT OPERATION

The part has internal current limit function, which is detected cycle by cycle. When its maximum inductor current limit is reached the charging cycle is terminated, and the low-side MOSFET is turned on to allow the inductor current to decrease. Under extreme overloads, such as short-circuit conditions, it reduces the oscillator frequency to 220KHz to allow further inductor current reduction and to minimize power dissipation.

APPLICATION INFORMATION

INDUCTOR SELECTION

In normal operation, the inductor maintains continuous current to the output. The inductor current has a ripple that is dependent on the inductance value. The high inductance reduces the ripple current. In general, select the inductance by the following equation:

$$L = \frac{V_{OUT} \times (V_{IN} - V_{OUT})}{V_{IN} \cdot f \cdot \Delta I}$$

Where V_{OUT} is the output voltage, V_{IN} is the input voltage, f is the switch frequency, and ΔI is the peak-to-peak inductor ripple current. Typically, choose ΔI as the 30% of the maximum output current.

Manufacturer	Part Number	Inductance (uH)	DRC max (Ohms)	Dimensions L*W*H (mm3)
Murata	LQH5B PN	1	0.019	5*5*2
		2.2	0.030	
	LQH44p N	1	0.036	4*4*1.7
		2.2	0.049	
WURTH	744373 24022	2.2	0.061	4.4*4.05

Table 1. Recommend Surface Mount Inductors

INPUT CAPACITOR SELECTION

The input capacitor reduces input voltage ripple to the converter, low ESR ceramic capacitor is highly recommended. For most applications, a 10uF capacitor is used. The input capacitor should be placed as close as possible to VIN and GND.

OUTPUT CAPACITOR SELECTION

A low ESR output capacitor is required in order to maintain low output voltage ripple. In the case of ceramic output capacitors, capacitor ESR is very small and does not contribute to the ripple, so a lower capacitance value is acceptable when ceramic capacitors are used. A 22uF ceramic output capacitor is suitable for most applications.

OUTPUT VOLTAGE PROGRAMMING

In the adjustable version, the output voltage is set by a resistive divider according to the following equation:

$$R_1 = R_2 \times \left(\frac{V_{OUT}}{0.6} - 1 \right)$$

Typically choose $R_1=100K$ and determine R_2 from the following equation:

Connect a small capacitor across R_1 feed forward capacitance at the FB pin for better performance.

LAYOUT SUGGESTION

The several guidelines should be followed when doing the PCB layout.

- 1, The input and output capacitors should be placed very close to the device, to keep the loop resistance very low and the switching loop very small.
- 2, All ground connection must be tied together. Use a broad ground plane to establish the lowest resistance possible between all connections.
- 3, The FB pin connection should be made as close to the load as possible so that the voltage at the load is the expected regulated value.
- 4, The switch node connection should be low resistance to reduce power losses.

TYPICAL PERFORMANCE CHARACTERISTICS

(VIN=VEN=5V, L=2.2uH, CIN=10uF, COUT=22uF, if not mentioned)

Efficiency vs. Output Current

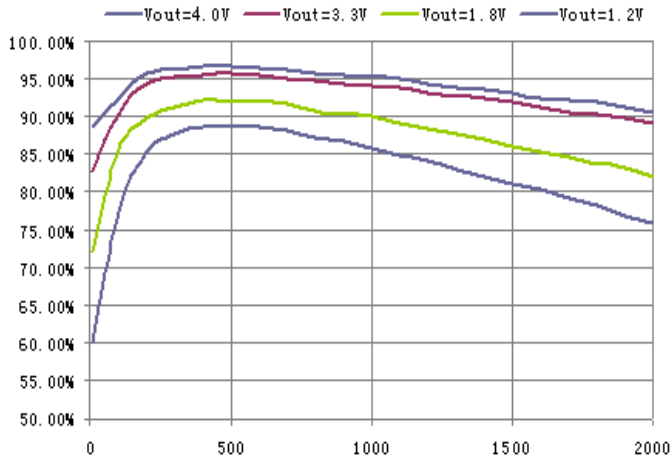

Efficiency vs. Output Current(Vout=3.3V)

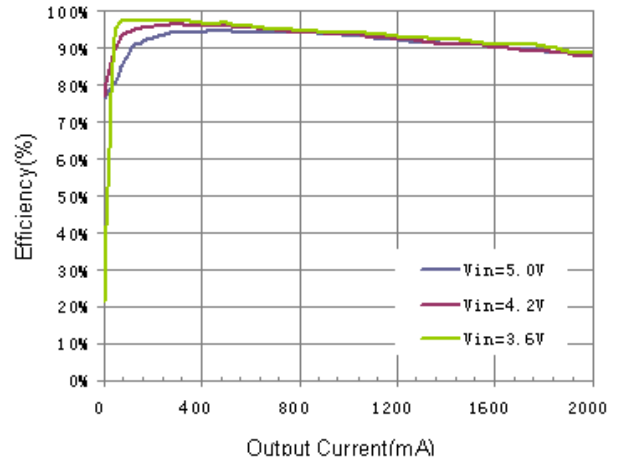

Efficiency vs. Output Current(Vout=1.2V)

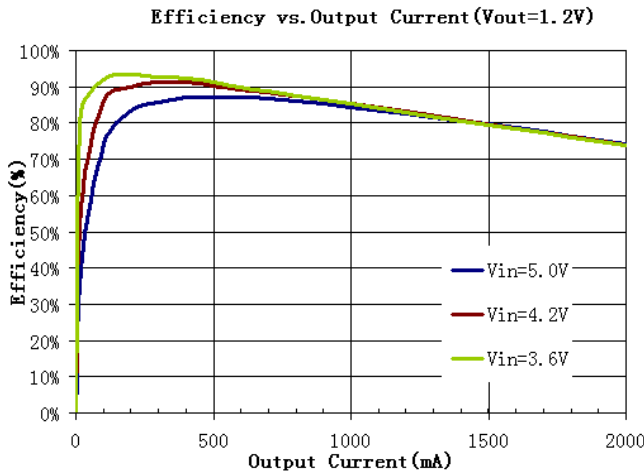

Input Current VS. Input Voltage (Vout=3.3V)

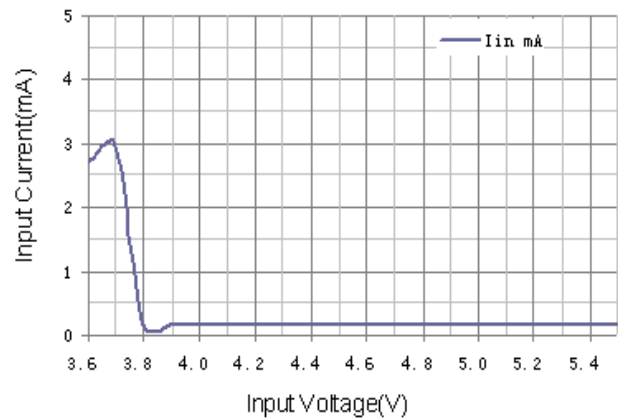

Efficiency vs. Output Current(Vout=1.8V)

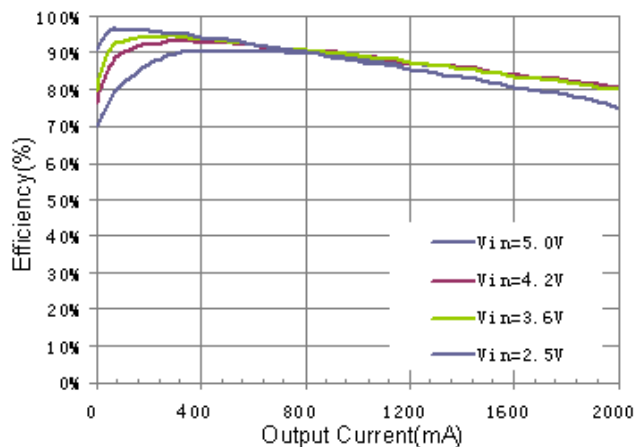

Oscillator Frequency vs. Temperature

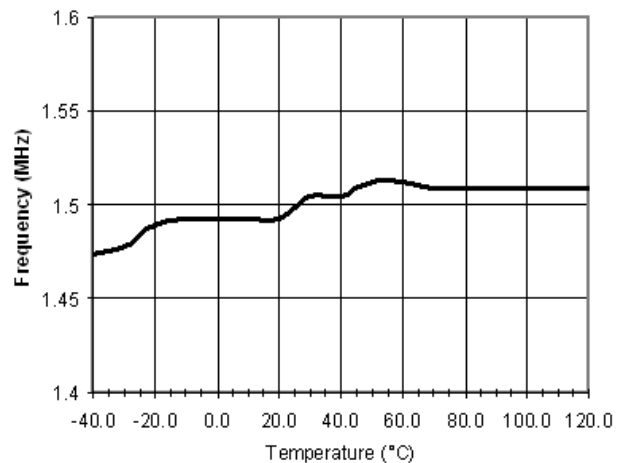

Reference Voltage vs. Temperature

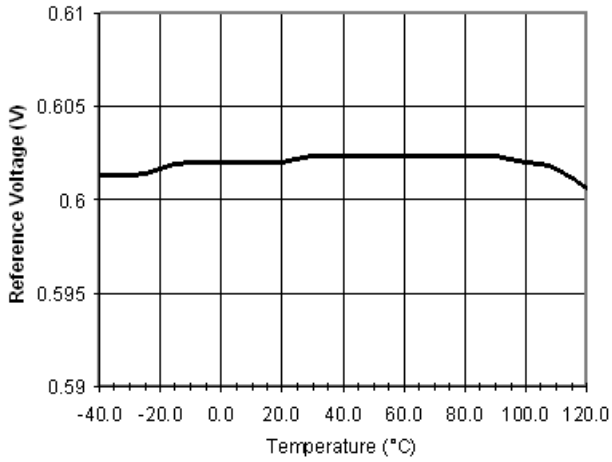

Output Voltage VS. Output Current (Vout=3.3V)

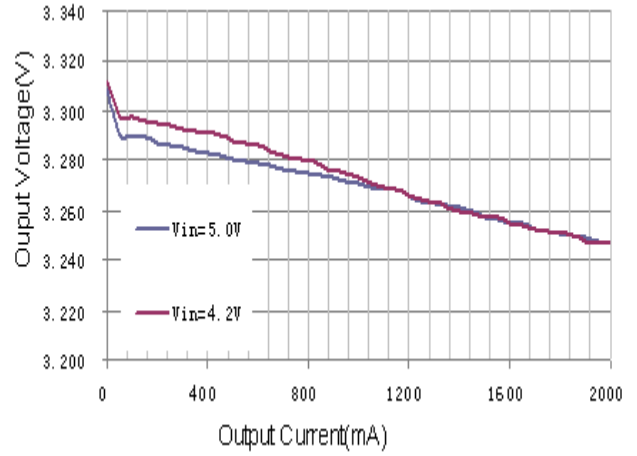

Output Voltage VS. Output Current (Vout=1.2V)

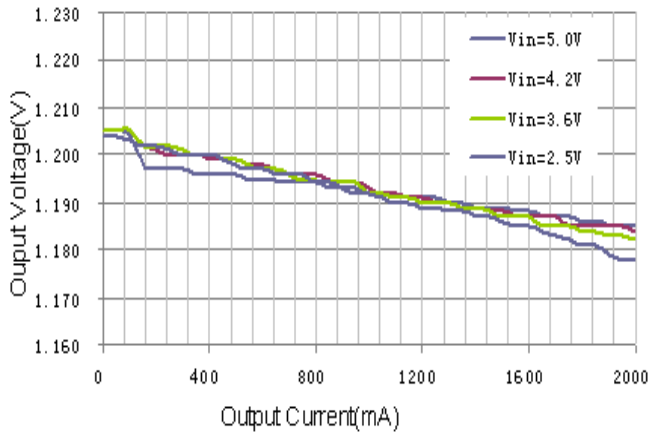

Steady State Waveform

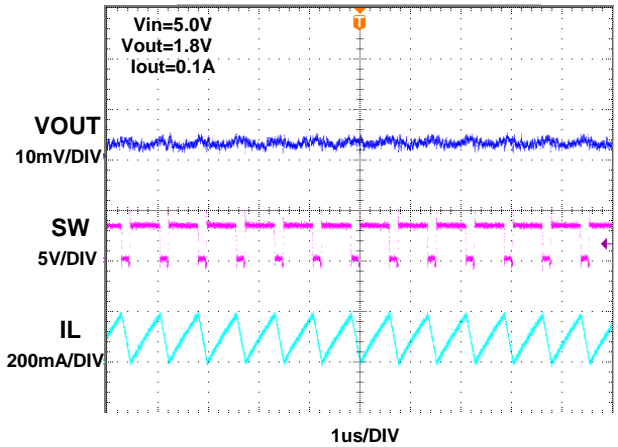

Output Voltage VS. Output Current (Vout=1.8V)

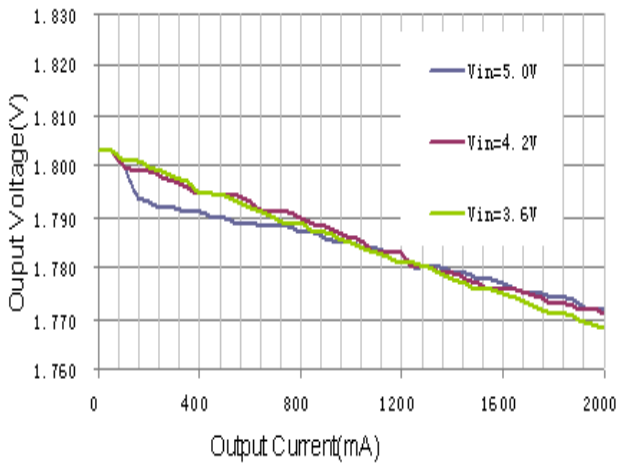

Steady State Waveform

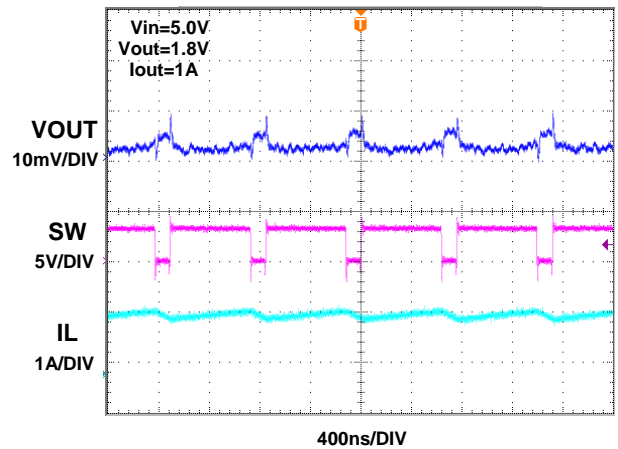

Transient Waveform(Vout=3.3V,Iout=0.15A-1.5A)

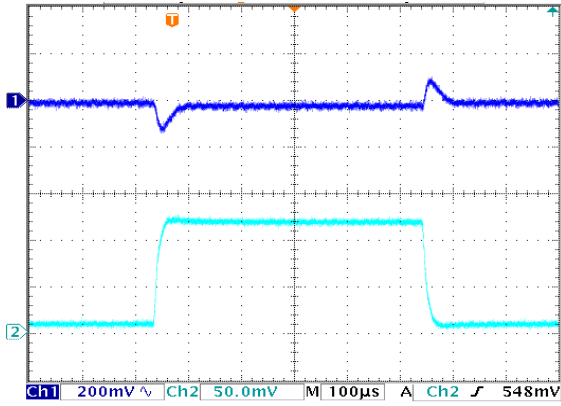

Startup through Enable Waveform

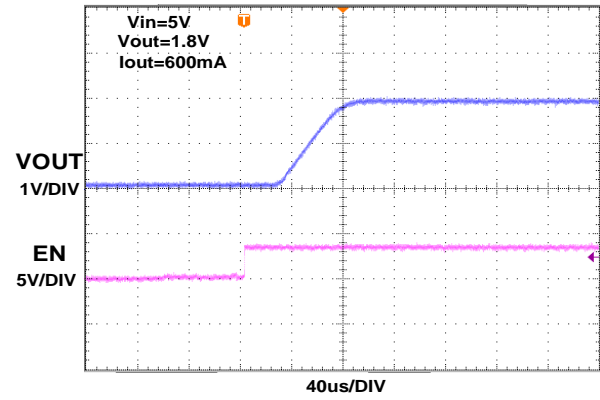

PACKAGE OUTLINE

DFN-10L 3MM X 3MM PACKAGE OUTLINE AND DIMENSIONS

